

INSTALLATION MANUAL

MEMORY ADAPTERS

FOR

KWM-380/HF-380 TRANSCEIVERS

**Kiron Corporation
1516 Essex Road
Columbus, OH 43221
614-481-0542**

Index

Topic	Page
Installation of the memory adapter	2
Electrical testing	11
Troubleshooting	12
Appendix A - ROM socket installation hints	15
Appendix B - ROMS & transmit frequencies	18
Appendix C - Battery lifetime estimates	24
Appendix D - Adding a keypad	28
Ordering the Pipo keypad	30
Keypad operation with Kiron Memory Adapters	32
Appendix E - Connection to a computer	35
Warranty	39

Revised September 1994

I. Introduction

Congratulations on your purchase of the Kiron Memory Adapter. There are three models of the memory adapters. The Model M1-A is for a standard KWM-380. The M3-A is also for a standard KWM-380 but provides increased transmit frequency coverage. The Model M2-A is for the HF-380 military transceiver or for a KWM-380 which has had an additional filter board (A3) installed. The ROMs on the Kiron boards contain copyrighted modifications to the original Rockwell control program. Each model has a unique ROM and program. These matters are further explained in Appendix B of this manual. We suggest that you read this material now in order to verify that you have ordered the correct memory adapter for your particular radio.

This manual tells how to install the memory adapters and how to use the transceiver after the adapter is installed (some of the keypad operations are different). The manual also provides some additional information about the KWM-380/HF-380 transceivers and about the technology used in the KIRON memory adapters.

The KWM-380 control card contains a 6802 microcomputer (U2). A microcomputer combines a microprocessor and memory in a single IC package. Unfortunately the original designers of the KWM-380 made no provision for preserving the memory contents on power down. The permanent control program in the ROM is written so that each time the power is turned on the memory is reinitialized to set values. This is why the radio returns to 15 MHz each time it is turned on. Also the lack of battery backup for the memory severely limits the usefulness of one of the radio's best features, the keypad memory. The 6802 contains only 128 bytes of memory, 44 of which are used to store the 11 keypad memory frequencies with the remainder reserved to store other quantities required for the operation of the control program. Our Kiron adapter board adds 2048 bytes of new battery backed memory to supplement the 6802's 128 bytes. New battery and memory technology (see Appendix C) permits extremely long battery lifetime. The Kiron boards also have a new ROM with copyrighted modifications to the original Rockwell control program which are required to support the changed memory configuration. The new memory capacity and the new program permit increasing the memories to 100. And of course all of the memories and the A and B vfos are preserved at all times.

We are confident that our product will greatly enhance your enjoyment of the transceiver.

The installation is not difficult but needs to be done with care. We have written this manual for someone who has never opened the case of a KWM-380 or HF-380. On the other hand if you have, for example, installed a crystal filter in the transceiver you have all the skill needed for this job.

Even if you are a technician experienced in servicing these transceivers we suggest that you scan the following paragraphs and read with care any sections with which you are not familiar. Look especially at the cautionary statement in section V, the installation instructions in section VI, and the electrical testing procedures in section VIII.

II. Summary

When the dust cover is removed (see details below) you will find a large metal box on the left side which has a cover secured by 34 sheet metal screws. When this cover is removed you will see a series of circuit cards, held in place by card guides, and separated by brass shield partitions. The third slot from the front contains a full-width card called the control card (A8). Figure 1 shows the card locations.

The installation of the Kiron Memory Adapter consists simply of removing the control card, substituting the supplied circuit board for the ROM IC on the control card, and soldering three wires to the control card. In other words the Kiron board mounts piggyback style to the control card.

III. Order of Procedures

The installation description consists of five parts:

1. Disassembly in order to gain access to the control card.
2. Removal of the control card.
3. Installation of the memory adapter board.
4. Electrical performance checks.
5. Reassembly of the transceiver.

These steps are described in detail below. Up to an hour and a half should be allowed for the modification to be completed.

IV. Disassembly of the transceiver

The only tool required for this part is a Phillips screwdriver. We recommend covering a portion of the work area with a folded large towel in order to prevent scratching of either the transceiver cabinet or the work table itself.

Begin by removing the ac power cord, the keypad cable, etc. To remove the dust cover you will remove four screws located adjacent to the feet on the bottom of the transceiver. Place the transceiver upside down on the table for this step. After the screws are removed turn the transceiver right side up and if another person is available have him hold the dust cover while you pull the transceiver chassis forward out of the dust cover. If you are working alone it may help to place the radio on its right side and carefully tip it forward onto the right front edge of the front panel while at the same time sliding the dust cover off to the rear. Be careful not to damage the power switch. Also be careful that the dust cover does not hang up on any of the cables along the left side of the chassis.

Put the dust cover aside and place the transceiver chassis upright on the work table with the front panel toward you. Identify the shielded enclosure and begin to remove the 34 machine screws. Note that three screws located in a row about 1 1/8 inches from the front of the box are larger diameter (and shorter) than the rest. Remove these first and keep them separated from the remainder. Note that each screw has a lock washer and a flat washer and that one screw near the left rear has a solder lug under the screw instead of a separate flat washer. Remember these items for use later during reassembly.

V. Removal of the Control Card

After the cover is removed locate the control card and examine the cables connected to it. There are six multi-wire ribbon cables and two single wires. In addition there is one coax cable which you may not be able to see until you begin to slide the card up out of the card guides.

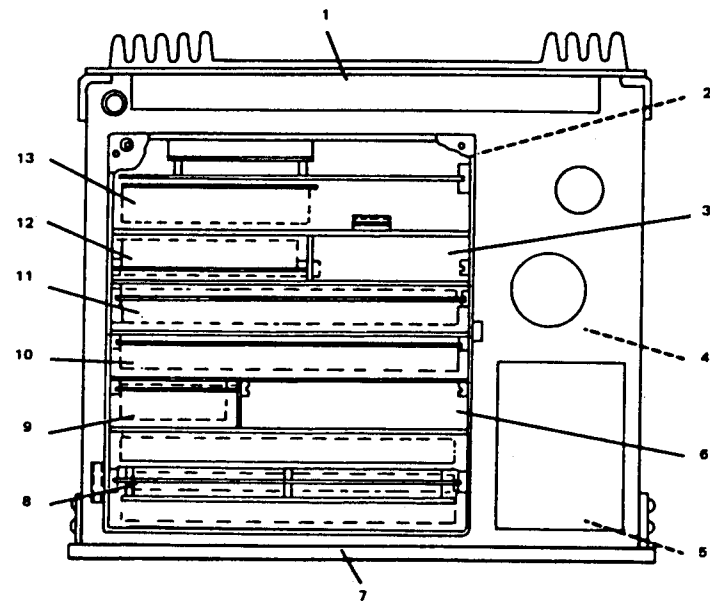

- | | |
|---------------------------------------|--|
| 1. POWER AMPLIFIER (A1A1) | 8. SYNTHESIZER (A5) |
| 2. RECEIVER-EXCITER (A3) | 9. OSCILLATOR (A7) |
| 3. SPEECH PROCESSOR (A12)
(OPTION) | 10. CONTROL CARD (A8) |
| 4. POWER SUPPLY
CONTROL (A9A1) | 11. PASS BAND TUNING (A4) |
| 5. +24 V REGULATOR
(A9A2) | 12. PASS BAND TUNING (A13)
(OPTION) |
| 6. NOISE BLANKER (A11)
(OPTION) | 13. LOW PASS FILTER (A2) |
| 7. DISPLAY (A10A1) | |

Figure 1: Circuit Card Locations

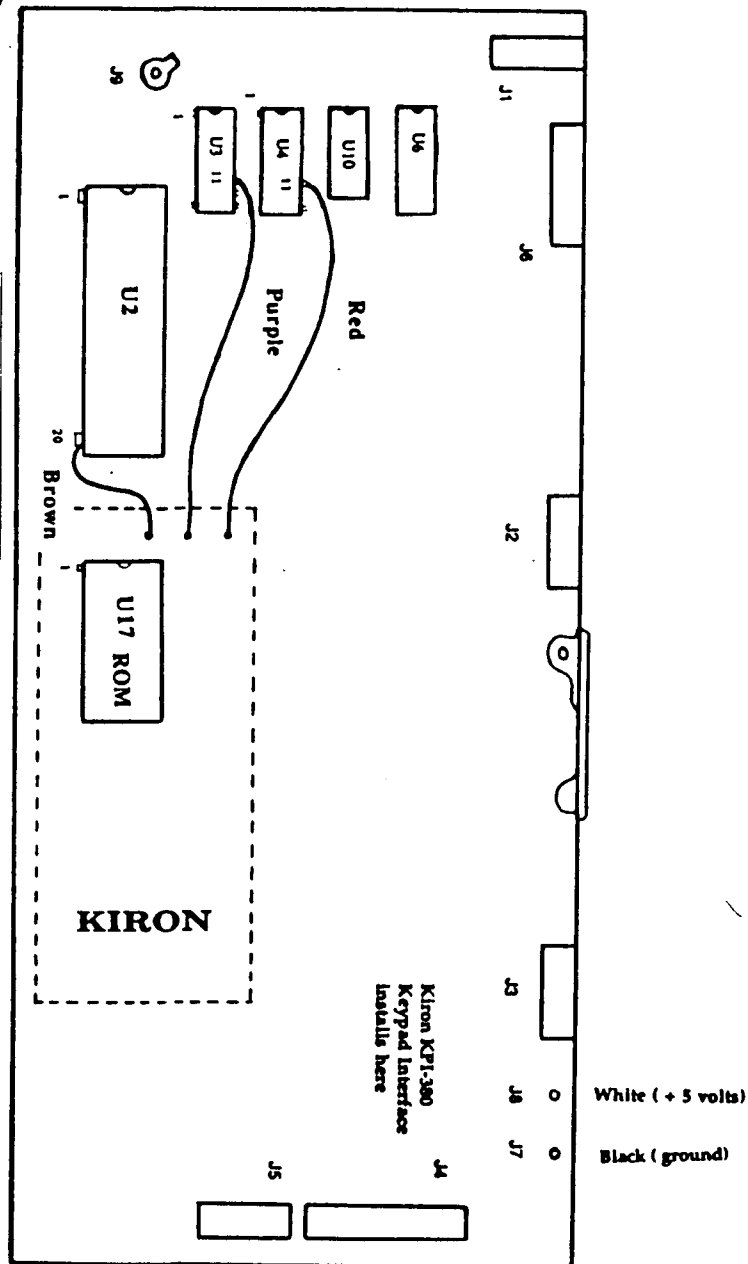

Figure 2: Control Card (A8)

With the exception of the two single wires near the upper right corner of the card, it is not possible to make an error in reassembly since each cable has a different number of conductors and a unique connector with blank key pin. Fig 2 shows the location of the various connectors.

CAUTION

The two single wires are +5 volts and ground. They must not be mixed up during reassembly. Note that the white wire is on the left and is labeled P8 and that the legend J8 +5 is on the circuit board adjacent to the pin. This is the +5 volt wire. The black wire is on the right and is labeled P7 and the circuit board is labeled J7 GND next to the pin. This is the ground wire.

In the next steps you will gradually slide the control card upwards and remove its attached cables. As each cable is removed try to keep it out of the way by placing it in another slot or under another wire in an adjacent slot. The removal steps are as follows (Refer to Fig 2):

1. Raise the white card handle and pull the control card up slightly until about 1/4 inch protrudes above the box.
2. Next remove P2 which is along the top edge of the card near the center.
3. Next remove P3. Note how the cable loops down inside the box. On reassembly it should be installed in the same manner.
4. Now remove the single white and black wires, P8 and P7.
5. Look for a wide blue ribbon cable running along the outside of the shield box and terminating in P11 on the next card to the rear of the control card. On most radios this cable is over two rainbow (i.e. multi-colored) cables which go to J4 and J5 on the control card. If this is the case, pull up the filter card about 1/2 inch and remove P11.

NOTE

There will be a cable on J4 only if you have a keypad interface such as the Rockwell AC-3803 or the Kiron KPI-380. See Appendix D.

6. Now pull up the control card another inch or so and remove P6 and P1 on the left side of the control card. Note how these cables go through a slot on the left side of the shield box. On reassembly they must be positioned in the same manner so that they do not interfere with the dust cover.
7. Now slide the control card up another inch or so and remove P4 (right side).
8. At this time the card can be pulled up the rest of the way and P5 (right side) and the coax connected to J9 (lower left) can be removed. P5 has a tendency to fall down into the box so pull it up and away from the box. This will make reassembly a little easier.

The control card should now be free of the radio and we are ready to proceed with the installation.

VI. Installation of the Memory Adapter Board on the Control Card.

1. Place the control card on the work surface (a conductive surface is recommended) component side up and compare with Fig 2.
2. Locate the ROM, U17, in the lower center of the board. The ROM should be socketed. In a very few early radios the ROM is soldered to the board. If this is the case do not proceed unless you are experienced at IC removal. If you cannot obtain local assistance contact KIRON for advice. We have included our hints and recommendations concerning sockets in Appendix A.
3. Next locate the microprocessor, U2, which is the large IC to the left of the ROM.
4. Notice the four smaller IC's running up the board from the top left corner of the microprocessor. They are U3, U4, U10 and U6, see Fig 2. We will be making connections to the microprocessor and to the lower two IC's, U3 and U4. Note that U3 is clearly labeled to the left of the IC itself but that U4 has the label between U3 and U4 and the label for U10 is just above U4.

CAUTION

Make sure that you have identified the proper IC's U3 and U4 by comparing the board and our figures.

5. Remove the ROM from its socket using an IC lifter or a small flat screwdriver. Work alternately from both ends being careful not to bend the pins. Put the ROM aside. It will not be needed but you will probably want to save it.
6. Next identify the three pins on U3, U4, and U2 as noted in Fig 2. Using a small-tip IC type soldering iron and the small diameter solder supplied, tin the pins by applying heat for a maximum of 5 seconds. Overheating can damage either the IC or the circuit board. Use only a small amount of solder. Despite our cautionary statements damage is very unlikely. Be sure that you apply enough heat so that the solder flows. We don't want any cold solder joints! Inspect the finished work to be sure there are no solder bridges to adjacent components, pins, or traces.

The soldering iron should have a maximum of 25 watts and a three wire cord type with grounded tip is best. If you do not have a suitable iron an inexpensive choice is available from Radio Shack for \$7.49 (#64-2052)

7. Carefully insert the Kiron Memory Adapter board into the ROM socket being careful not to bend any pins.

Note that when properly installed the word KIRON is still visible, i.e. the board is designed so that the major components are under the board.

8. Finally solder the wires as shown in Fig 2 to the previously prepared IC pins. There are three wires coming from the Kiron board. The upper one [Red] goes to U4, pin 11; the middle one [Purple] goes to U3, pin 11; and the lower wire [Brown] goes to pin 20 of the microprocessor, U2.

The installation is now complete. As a final step you may wish to dress the wires against the board and secure them with a drop of silicone cement such as Dow Corning General Purpose Sealant which is available at any hardware store. A rubber bumper has been included which can be placed on the new ROM, the component under the word

KIRON, to act as a spacer between the Kiron board and the Control Card. Whether it should be used or not depends on the height of the socket on your Control Card.

Note that the pins on the new board are a little long so that some of the pin shows even when the board is correctly installed. For a proper installation just press down firmly until the pins have reached the limit of their travel.

The conductive foam and conducting bag may now be used to store the Rockwell ROM.

VII. Reinstallation of the Control Card.

The card is now ready to be returned to its slot and the cables reconnected.

1. Start by inserting the coax into J9. Be careful that the center conductor goes through the hole in the board and is not bent over.
2. Now start the card into the guides and install P5 (lower right). Make sure that the two coax cables pass in front of the Kiron board and do not get caught on the board as it is reinserted.
3. If you have a keypad install P4 (right side), lower the card a little and install P6 and P1 (left side). Get the cables attached to P6 and P1 dressed inside the shield box as they were before.
4. Lower the card some more and insert P3. Dress the cable in front of the board as it was before removal.
5. Lower the control card more and now install P11 on the filter board and slide the filter board down until it seats.
6. Install the single wire connectors P8 (white, on left) and P7 (black, on right). Check this again now to be sure there is no error. See Section V above.
7. Finally install P2 and seat the control card at the bottom of its travel.
8. Make a final check of all connectors to be sure they are firmly in place.
9. There is a slot in the top edge of the shield partition just in front of P3. In addition to the cable for P3, there should be two coax cables and a small 4 conductor ribbon cable in this slot.

If all is in order you may proceed to the electrical testing of the radio before installing the shield box top cover.

VIII. Electrical Testing

1. Attach the ac cord and the keypad.

If you do not have a keypad just turn on the radio. There should be three beeps and the vfo's should both indicate 15.0 MHz. Now manually tune the vfo's to new frequencies. Turn off the radio. Turn it back on and note that the new frequencies are retained. The following paragraphs assume that the radio is keypad equipped.

2. Press and hold two keys on the keypad (5 and CLR) while turning on the ac power switch. [Some keypads may not have a key labeled CLR. It is the lower right hand key at the bottom of the fourth column.]
3. The radio should beep three times and indicate 15.0 MHz on the VFO A or B position. Release the keys after the three beeps.
4. Proceed to store some frequencies in a few of the memories. There are now 100 memories.

Note: If you did not previously have a WARC ROM there is a change in keypad operation. The non-WARC ROM had ten memories addressed with a single key as 0 through 9. The KIRON Memory Adapter has 100 memories addressed as 00 through 99. In other words you must now press two digits when storing or recalling a frequency from memory, e.g. STO 05 or STO 89. Also Appendix D has a nice section on keypad operation which may include some information and hints which are new to you. In particular the RCL key operates differently.

5. Switch to the B VFO and set it to some frequency of choice.
6. Now turn off the power. Wait a few seconds and turn the radio on again. The VFO's will have the same frequencies as before.

Step through the memories and verify that they are still there.

This completes the checkout. You are now ready for many years of enjoyment.

Should you ever want to clear all the memories and "start afresh", just repeat the power-on procedure, i.e. press 5 and CLR while turning on the ac power. This will clear all memories and reset the A and B VFO's to 15.0 MHz.

IX. Troubleshooting

Experience with several hundred customers has shown our products to be remarkably free of difficulties. In all but a few cases the units performed as desired from the first installation. The following hints may be helpful should you encounter difficulty.

The software in the transceiver monitors a number of possible trouble spots in the radio and if a fault is detected special hardware is activated which causes a continuous beeping of the sidetone oscillator to be heard through the speaker. For example difficulty with the synthesizer will activate the beeping. Difficulty with the control card will also activate the beeping. This could occur for example if the microprocessor failed to initialize properly. There could be a number of reasons for the failure but one of them could be that the Kiron board has lost its contents. We have provided a means for overcoming this type of problem. Just turn off the power and perform the power-on reset procedure which was described at the end of the last section (5 + CLR keys held down while power is turned on). In most cases this will correct the problem although you will have to reload the memories.

We have cycled our transceiver on and off thousands of times using a computer to turn the ac power on and off at 15 second intervals thus proving the basic design. A service letter from Rockwell emphasizes the importance of setting the proper primary taps on the power transformer. In one case one of our customers had a situation where the Kiron board would periodically lose memory. Resetting the primary taps cured the problem. The following is the statement from Rockwell service:

"It has come to our attention that strapping of the power transformer on KWM/HF-380 radios is, in many cases, being done incorrectly. If the transformer is strapped at a voltage much higher than the actual line voltage, poor regulation of DC supply voltages may occur exhibiting numerous signs of malfunction. Be sure to strap the power transformer at or lower than the actual line voltage. The right rear heat sink should run warm with proper strapping."

Page 8 of the user manual describes the strapping procedure. The terminal strip is at the left rear corner of the underside of the chassis and is under a fiberglass cover.

Microprocessor systems depend for their proper operation on correct supply voltages. Also the rate of rise and fall of voltages is very important. In order to insure proper operation one should not turn the power on for at least five seconds after turning it off. Very rapid cycling of the power switch could induce a failure. No permanent damage would occur but the master reset procedure would have to be followed.

The Control Card voltage should be 5.0 volts. If you follow the black and white single wires from the control card you will discover an IC bolted to the right hand outside wall of the card cage. This is a type 7805 three terminal five volt regulator. They are usually quite reliable but may occasionally give difficulty.

One of the first steps in troubleshooting a non-functioning memory board would be to reinstall the original ROM and see if the radio is still operational. One customer found it was not and eventually found an unrelated difficulty which just chose to happen during the installation!

One long shot possibility for trouble which we have never observed but which is nevertheless possible is the following. ICs U3 and U4 on the control card are 3-to-8 line decoders. At pin 11 we use a portion of these ICs that is not utilized in the original radio. It is theoretically possible that U3 or U4 could be defective and thus prevent our board from functioning. We repeat that we have never observed this.

For completeness we might also mention that the control card does not have a separate crystal oscillator for the microprocessor. Instead a signal is brought over from the synthesizer for clocking the microprocessor. Thus if the synthesizer is not functioning the control card can not function either.

If you should experience difficulty we ask that you try the reset procedure. Should this not solve the problem please notify us and we will try to be of assistance.

X. Final Reassembly

1. Check again the positions of all cables to be sure that none will be pinched when the shield cover is replaced.
2. Replace the cover and tighten all screws securely. This is an important step. If you tighten too much you will "strip" the receptacle. On the other hand if the shield cover is not firmly in place you will have birdies in the receiver. Just tighten each screw firmly according to good mechanical practice.
3. Now reinstall the dust cover. Be careful not to damage the cables along the left side as you slide the cover on.
4. Turn the transceiver upside down and replace the four bottom screws.

XI. Final Comments

This completes the installation of the KIRON Memory Adapter. We invite your comments and hope that you will tell your KWM-380/HF-380 friends about our product. Should you ever have difficulty we are at your service.

KIRON CORPORATION
1516 Essex Road
Columbus, OHIO 43221
USA

614-481-0542

ROM SOCKET INSTALLATION HINTS

The battery backup memory adapters from Kiron Corporation attach in place of the ROM integrated circuit at location U17 on the Control Card (A8), see Fig. 2 of the main text.

The vast majority of KWM-380/HF-380s have the ROM in a socket which of course makes for a very simple installation. However, some early radios have the ROM soldered into the PC board. If this is the case the old ROM must be removed and a socket installed before the Kiron board installation can proceed.

The information that we have suggests that Rockwell-Collins began to install the ROM in a socket with Rev J of the Control Card which corresponded to about KWM-380 serial number 520. We have no information on the HF-380. However, a great many of the early KWM-380s were retrofitted with a socket if the extended frequency (i.e. WARC ROM) option was installed by the factory service facility. For those few owners who still have a radio with a soldered-in ROM, this memo should make the process of installing a socket as painless as possible. Of course the concern is that we want to remove the old ROM without damaging the PC board traces.

We have had considerable experience with the use of sophisticated (i.e. expensive) desoldering tools and have concluded that it is a mistake even with such special equipment to try to remove the old ROM intact. Invariably one pin sticks and while applying lifting pressure, a pc trace is damaged. There are times of course when it is imperative that the old part be saved. But in this case the old ROM is of no use and therefore the best procedure is to sacrifice the old ROM.

Begin by cutting the pins from the old ROM with a pair of pointed cutters. We use a pair of Xcelite 96CG snips, see Fig. A1. These are available at electronic parts houses for about \$7.00 to \$10.00. A less expensive alternative is available from Radio Shack. They call them Nippy Cutters (#64-1833) and the cost is \$3.99. The important thing is to clip off each IC pin at the IC, not at the level of the PC board. When all of the pins have been cut the plastic body of the IC will drop away

and you are now left with 24 pieces of metal, each one soldered into a hole. Now apply heat with a small soldering iron to a pin and when the solder is melted, grasp the pin with a pair of tweezers or pliers and remove it. This process goes very smoothly. You are then left with some or all of the holes filled with solder. Now go back over the holes one by one with the soldering iron and a spring-loaded vacuum desoldering tool such as the Radio Shack #64-2120 (\$5.99) and clear out the solder. Sometimes we use the tool above the board alongside the soldering iron as suggested in the instructions and sometimes we place the tool below the board and the iron above the board and pull the solder through the hole although in this latter procedure it is sometimes difficult to get the desoldering tool tip centered properly below the hole. If you have trouble clearing out a hole it may be because it is partially open already. In this case we have found it helpful to first apply solder to fill the hole. Then try again with the tool. The fresh solder is now usually removed very easily. Sometimes we also use a simple soldering bulb (Radio Shack #642086, \$1.99) instead of the #64-2120 tool.



Fig A1

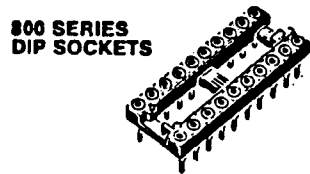

Fig A2

After the holes are cleaned up, make a visual inspection of the board to make sure that no solder remains between traces. When you are satisfied insert the socket and solder it. Be sure to install the socket with pin 1 to the left as viewed from the top of the board, see Fig. 1 of the main text.

Finally we can make a recommendation concerning the IC socket itself. We recommend a higher quality socket than Rockwell-Collins used. Fig. A2 shows a low-profile "machined pin" type IC socket. The one shown is an Augat type 824-AG11D which costs about \$3.50 from Newark Electronics or other parts houses handling Augat products. The machined pin design is recognizable by the round pins and round socket

holes as can be seen in the figure. This design provides a superior gripping action and long life, thus securely holding the IC or the Kiron Memory Board. For longest troublefree operation one should use the Augat 824-AG10D gold plated socket. Otherwise one runs the risk of galvanic action between the dissimilar metals of the plug and socket.. [The Kiron plug is gold-plated]. This type costs about a dollar more. The original setup was a tin type socket and a ROM with tin pins. Since the Kiron product uses gold plated pins it would be best if a new socket were made a part of all installations of the memory board.

We want to emphasize that the process is not at all difficult so long as you first cut off the IC pins and do it as high as possible off the pc board so that you have an adequate length of pin to grasp with the tweezers.

We hope that the above information is helpful and are always interested in your experiences with our suggestions so that we might improve the information we give future customers.

Appendix B

ROMS AND TRANSMIT FREQUENCY BANDS FOR 380 SERIES TRANSCEIVERS

There are three different ROMs which may be found in socket U17 of the control card. The part number is marked on the ROM. Part R1453-11 is the original KWM-380 ROM. It restricts transmit to the amateur bands in existence before the WARC frequency allocation convention. Most KWM-380s will have ROM R1453-12. This is so-called WARC ROM which permits transmission on the new amateur bands created by the WARC convention and also provides transmission capability on some frequencies above and below certain amateur bands which are allocated to the Military Amateur Radio Service (MARS). The HF-380 ROM is R1451-12 and of course it permits transmission on all frequencies from 1.8 to 29.99 MHz. There are a number of transceivers which have a KWM-380 front panel nameplate but they have been upgraded to HF-380s by the addition of a second low pass filter board in the transmitter. These radios would also have the R1451-12 ROM. However we have encountered some KWM-380 radios which have the R1451-12 ROM but have not otherwise been changed. This is not a recommended situation and severe difficulties can occur. We suggest that if you suspect that the radio you own has been modified that you read the following information carefully and check your radio before installing a KIRON memory adapter board so that you may verify that you have ordered the correct memory adapter model.

Kiron Corporation offers three models (M1-A, M2-A, M3-A) of our memory adapters for the ROCKWELL 380 Series transceivers. The three models differ only in the copyrighted computer program contained in the on-board ROM, as is explained below. The M1 is identified by a green dot on the ROM; the M2 by a yellow dot; and the M3 by a red dot.

On transmit both the KWM-380 and the HF-380 transceivers direct the power amplifier output through a low pass filter and directional coupler assembly and then to the antenna. The filters are switched in or out of the circuit by means of relays. At each frequency the microprocessor on the Control Card (A8) selects the proper filter relays in accordance with a table stored in the ROM and also provides

necessary time delays in order to prevent "hot switching" of the relays. The low pass filter-directional coupler assembly is located at the rear of the card cage. A brass plate goes across the full width of the cage. The KWM-380 contains one filter board (A1) with five filters designated LP1, LP3, LP6, LP8, and LP9. It is located on the left side and is mounted on the front of the brass plate. The HF-380 contains a second filter board (A3) with additional filters designated LP2, LP4, LP5, and LP7. If present this board is to the right of the (A1) filter. The assembly under discussion also includes a directional coupler board (A2) which is located on the left side and to the rear of the (A1) low pass filter board. The purpose of the filters, of course, is to reduce harmonic and spurious emissions. Figures B1 and B2 show the low pass filter cutoff frequencies for the KWM-380 and the HF-380 respectively.

There is another difference between a KWM-380 and an HF-380. When a KWM-380 is converted to an HF-380, in addition to the installation of the (A3) filter board it is necessary to remove four diodes (CR3, CR6, CR7 and CR9) from the Control Card (A8). The filter which is selected is a combination of software (the program in the microprocessor ROM) and hardware (a wired-OR circuit using the above mentioned diodes). For example if a transmit frequency between 2 and 3 MHz is selected and the diodes are not removed, both LP2 and LP3 will be selected with undesirable consequences. However, if the (A3) filter board is not present the diodes guarantee that the next higher filter will be selected, in this case LP3.

Kiron Corporation manufactures three different memory boards which will now be described. The information to be discussed is summarized in Table B1 and Figures B1 and B2. A particular low pass filter switches out of the circuit at the frequency noted and the next higher filter switches in. For example in an HF-380 LP1 is OUT at 2 MHz and LP2 is IN at 2 MHz, see Figure B2. For a frequency between 2 and 3 MHz LP2 is IN. The normal WARC-ROM-equipped KWM-380 operates as shown in the top portion of Table B1. Note that although the nominal cutoff frequency of LP3 is 4.0 MHz, in a KWM-380 this filter is kept in-line through 4.25 MHz in order to provide harmonic suppression during 4.00 to 4.25 MHz MARS operation. This is possible due to the slow roll-off of the filter. In a similar manner LP6 is kept in-line to 10.15 MHz in order to accommodate the new 30 meter amateur

band and LP8 is not switched in until frequencies greater than 10.15 MHz are selected.

The lower part of Table B1 shows the filter selection for the HF-380 or for a KWM-380 which has been modified by the addition of the (A3) filter board and removal of the above mentioned diodes. There are now nine filters and the frequencies at which the filters are switched in or out are different. For example when operating on a MARS frequency just above 4.00 MHz, the HF-380 model selects LP4 instead of retaining LP3 beyond its normal cutoff frequency. The Kiron Model M2 operates in an identical fashion to the HF-380. It would not be advisable to install the HF-380 ROM (R1451-12) or our model M2 without installing the (A3) board and removing the diodes.

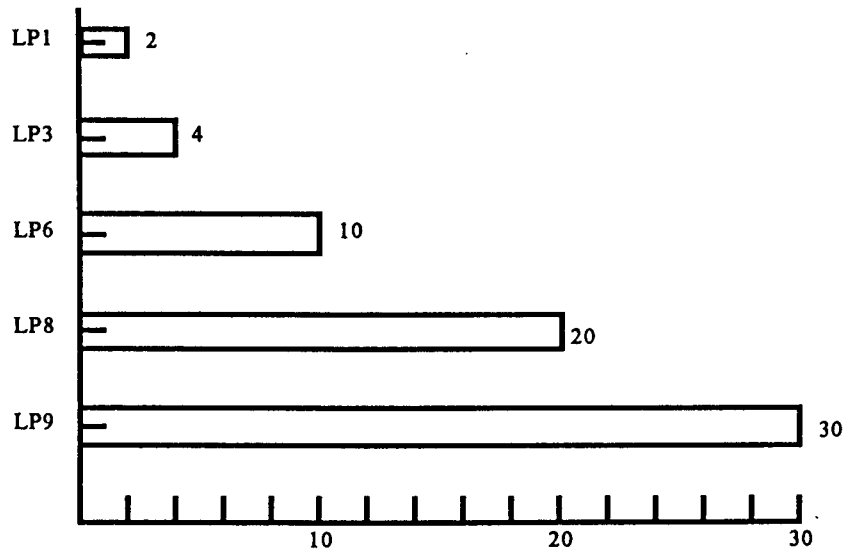

Figure B1: Low Pass Filters of the KWM-380.

The entries in the middle part of Table B1 are for the Kiron Model M3 which is intended for installation in a KWM-380 which has only the normal (A1) filter board installed and with the diodes on the Control Card still in place. However, the Kiron M3 permits transmitting on all frequencies from 1.8 to 29.99 MHz. A careful examination of Figure B1 and Table B1 will reveal the operation. Note that we have retained the filter selection frequencies from the normal KWM-380, see upper part of Table B1, so, for example, transmission at

4.10 MHz would still use LP3. However for any frequency between 4.25 and 6.75 MHz the M-3 will select LP6 which has a cutoff of 10 MHz. Thus for the range 4.25 to 5.00 MHz there will be no second harmonic suppression since the harmonic is below 10 MHz. For transmission between 10.15 and 20 MHz filter LP8 is selected. Note that for frequencies above 14 MHz the same filters LP8 or LP9 are selected by all models including the HF-380, in other words the extra HF-380 filters are all below this frequency as can be seen from Figure B2.

As long as the operator is aware of the above information and is licensed to transmit on frequencies outside the USA amateur bands or transmits only into a dummy load for laboratory testing, the M3 board should fill a need. Note that one should not remove the diodes when a Kiron M3 board is used.

There is no second harmonic suppression between 4.25 and 5.00 MHz when using the Kiron M3-A memory board in a standard KWM-380. Kiron Corporation assumes no responsibility for problems caused by harmonic or spurious emissions when transmitting in this frequency range. The (A3) filter board is recommended if transmission outside the amateur bands is anticipated. The additional filters may provide a benefit on receive as well as on transmit. Surplus Sales of Nebraska sells an (A3) board. If you anticipate adding the A3 board to a KWM-380 you would also want to change to the M2-A memory adapter.

If transmission is anticipated on only one frequency outside the amateur bands and if harmonic radiation is the major concern, a cost effective solution might be to construct a special low pass filter and install it between the transceiver output and the antenna for the band in question. General filter design information can be found in the ARRL Handbook and other engineering handbooks. Also a number of personal computer programs are now available which simplify the design of such filters

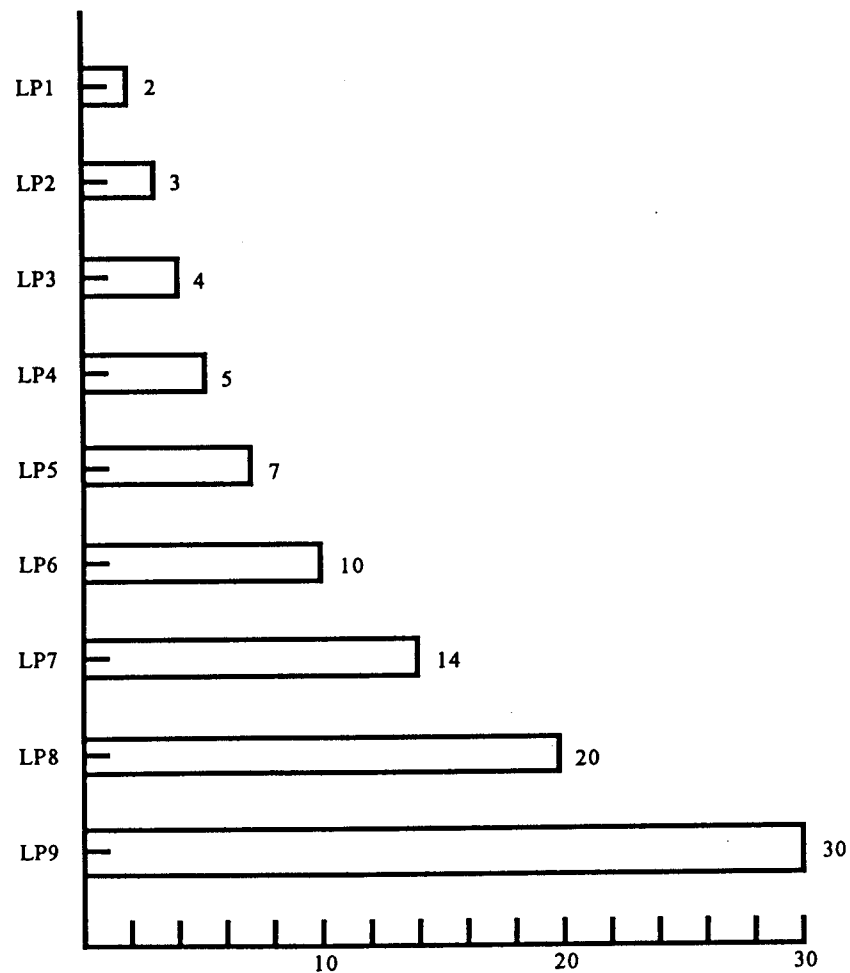

Figure B2: Low Pass Filters for the HF-380

Frequency Coverages of KWM-380/HF-380 Memory Boards from Kiron Corporation				
	Filter	Frequency (MHz)	Transmit Bands (MHz)	Amateur Bands
KWM-380/WARC ROM (also Kiron Model M-1) (Green Dot)	LP1	0 - 2	1.8 - 2.0	160
	LP3	2 - 4.25	3.25 - 4.25	80
	LP6	4.25 - 10.15	6.75 - 7.55	40
			10.10 - 10.15	30
	LP8	10.15 - 20.0	13.75 - 14.60	20
Kiron Model M-3 (Red Dot)	LP1	0 - 2	1.8 - 2.0	160
	LP3	2 - 4.25	2.0 - 4.25	80
	LP6	4.25 - 10.15	4.25 - 10.15	40
	LP8	10.15 - 20.0	10.15 - 20.0	30, 20, 17
	LP9	20.0 - 29.99	20.0 - 29.99	15, 12, 10
HF-380 (also Kiron Model M-2) (Yellow Dot)	LP1	0 - 2	1.8 - 2.0	160
	LP2	2 - 3	2 - 3	
	LP3	3 - 4	3 - 4	80
	LP4	4 - 5	4 - 5	
	LP5	5 - 7	5 - 7	
	LP6	7 - 10	7 - 10	40
	LP7	10 - 14	10 - 14	30
	LP8	14 - 20	14 - 20	20, 17
	LP9	20 - 29.99	20 - 29.99	15, 12, 10

Table B1: Filter Select Frequencies

Appendix C

Battery Lifetime Estimates

The Kiron Memory Adapters use a CMOS static RAM IC with two lithium batteries sealed within the IC package. The IC also contains the circuitry which automatically switches to the battery back-up mode when the mains power is turned off. Several vendors currently market such devices. Our product uses the MK48Z02 ZEROPOWER™ RAM made by Thomson Components - Mostek Division. We believe that it is the highest quality part available.

Lithium batteries of the type used in the Kiron Memory Adapters were developed in 1971 by Panasonic Corporation. You may be aware of the recent appearance of cameras with built-in flash and motorized film advance which will operate for five years on one battery. Not all "lithium" batteries are alike, however. The type used in our product uses a solid cathode and is referred to as lithium carbon mono-fluoride type. It has advantages of safety as well as extremely long shelf life partially due to the fact that the sealed package used in this application prevents loss of electrolyte. The following discussion is excerpted from the Thomson-Mostek data sheets.

Figure C1 illustrates the dependence of battery life on temperature. The life of the battery is controlled by temperature and is virtually independent of the percentage of time the IC spends in the back-up mode. The two curves in the figure are labeled ($t_{50\%}$) and ($t_{1\%}$). The curves represent accumulated life test data from over 100 million hours of continuous testing by Mostek. Extrapolating the data in Figure C1 shows, for example, that given a particular sample number of devices kept at 25 C (77 F), 1% of the devices may fail after 700 years and 50% are predicted to fail after 1100 years. Battery life is determined from date of manufacture. Each IC is marked with a date code in the form YYWW (Example: 8502 = 1985, week 2). The date code is near the Mostek logo in the center of the IC. The more prominent number in the lower left corner is a battery lot code. Our experience with conventional equipment which can be powered either from ac mains or battery would indicate that the batteries would last longer if the equipment was powered primarily from the mains. There are 8760 hours in a year. So for example if the KWM-380 was "used" 10% of the time the memory

would be backed up by the battery for 7884 hours per year. But our intuition misleads us for as stated above the battery life depends on temperature and our tests show that the KWM-380 internal temperature in the compartment which houses the memory adapter and battery is 17.5 °C higher than the ambient room temperature so that the battery which is intended for backup is actually being depleted more rapidly during the time that the radio is ON! This would be a distressing situation were it not for the extremely long battery lifetimes predicted by Figure C1. If a particular memory IC spends part of its life at one temperature and part at another, a mathematical equation is available to estimate the lifetime. Using this formula we have prepared the table shown on page 25. It has been assumed that the transceiver is ON (i.e. mains powered) 10%, 50% and 90% of the hours in a year. One set of numbers shows when 1% of the batteries will fail and the other set shows when 50% will fail. The results show that under severe conditions where the radio is kept in a room which is constantly at 40 °C (104 °F) throughout the year, and is turned on 90% of those hours, only 1% of the batteries will fail after 39 years. The failures will then begin to increase until 50% will have failed after 65 years. This could be correctly referred to as the average expected life. Under less stringent conditions the lifetime can exceed 100 years. Using this data we advertise a lifetime of 40 years.

Thomson-Mostek further states that the information presented in the Figure C1 represents a conservative analysis of the data presently available. Thomson-Mostek probably has the largest collection of battery life data available anywhere in the world. As more data becomes available, they believe that future read-points of tests now underway will result in longer life estimates than those presently given. However this seems a bit academic when the current predictions already exceed the lifetime of most of us! In spite of these optimistic predictions other sources insist that a battery lifetime of 10 years is more realistic.

We have been asked why we did not use a replaceable battery in a holder. The MK-48Z02 provides a low cost, simple design and in our view has a higher reliability (MTBF). The MK48Z02 memory IC is really a complex system which has been carefully engineered for reliability and long life. The memory current drain is as much as three hundred times less than conventional CMOS RAM ICs which are often

used in battery backup applications. The MK48Z02 uses two lithium batteries and the analog cutover circuitry contained in the IC automatically selects the battery with the highest voltage. This redundancy is just one example of the careful design we refer to. The MK48Z02 also incorporates analog circuitry to detect low mains power supply voltage. Whenever the voltage drops below 4.5 volts this circuitry protects the memory from accidental write cycles. **Most importantly the power fail detector is powered by the battery itself and not by the external 5 volt supply as is the case in many less carefully engineered systems.** This helps to prevent bad write cycles from the microprocessor. To the user this means that the Kiron board is less likely to lose data as compared to other designs. The batteries are sealed or encapsulated in the "top hat" of the IC. Sealing of the battery in the plastic case of the IC improves battery lifetime by preventing evaporation of the battery electrolyte. An external battery system would not have this advantage. In addition a sealed battery cannot leak electrolyte into the radio. For all of these reasons we feel that the Kiron design is the finest that could be implemented. The quality of the KWM-380/HF-380 deserves the best quality in add-on products.

External Temp °C	% ON, 1% Failure			% ON, 50% Failure		
	10	50	90	10	50	90
20	802	381	250	1357	633	413
25	500	293	152	857	400	261
30	321	150	98	547	257	168
35	202	94	61	342	159	103
40	129	60	39	214	100	65

Table C1: Battery Life in Years vs Percent Transceiver Usage and Ambient Temperature

There will undoubtedly be some failures of the memory IC due to manufacturing defects, lightning strikes of the transceiver or perhaps premature battery failure. In this case the old chip is desoldered from the board and a new one installed using normal IC replacement procedures. A socket could have been used but the result would have been increased cost with no benefit - in fact one could almost guarantee that eventually socket contact problems would appear.

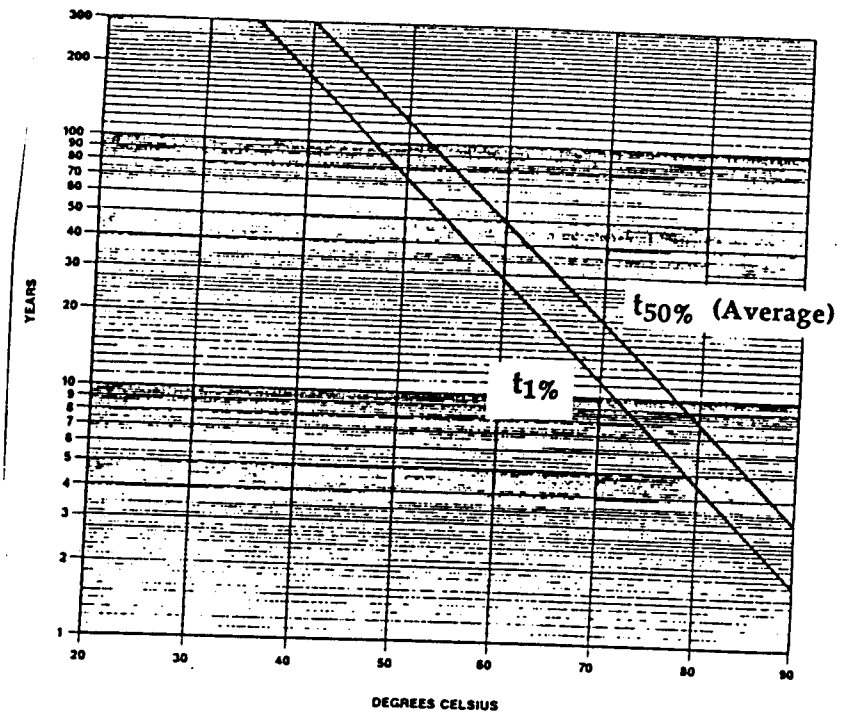

Figure C1: Battery Lifetime vs Temperature

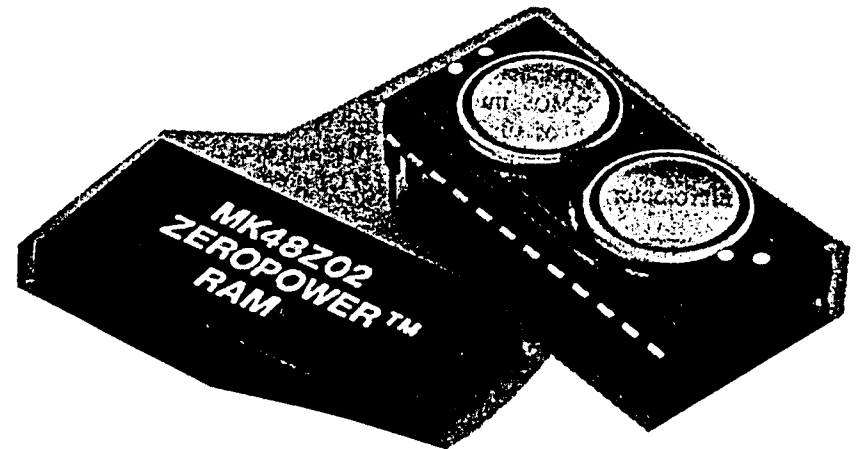

Figure C2: Photograph of Memory IC with top removed

Appendix D

ADDING A KEYPAD TO A 380 SERIES TRANSCIEVER

1. Description

The Kiron KPI-380 keypad interface kit interconnects a KWM-380 or HF-380 transceiver to an external keypad or computer. The kit consists of a circuit board with attached DB-25 connector and a ribbon cable with attached plug. The circuit board and DB-25 install in a cutout at the rear of the KWM-380 chassis. The plug at the end of the ribbon cable connects to J4 on the control card. From the keypad the operator can set the operating frequency of the transceiver or store and recall frequencies from memory. If used with a transceiver equipped with a Kiron Memory Adapter, up to 100 frequencies can be stored. The KPI-380 can also be used to interface the transceiver to an external computer, see Appendix E.

2. Installation

Installation of the KPI-380 consists only of mounting the circuit card via its DB-25 connector to the already existing cutout on the rear panel of the transceiver and plugging the ribbon cable to connector J4 on the transceiver Control Card. See Fig 2 of the main text for the location of J4.

To prepare for the installation the dust cover and the card cage cover must be removed. The procedures are described in Section IV of the main text.

- a. Next remove and discard the blank cover plate on the rear panel of the transceiver to expose the connector hole.
- b. The ribbon cable must be routed from the bottom rear of the transceiver and then along the right side of the card cage (as viewed from the top) to the Control Card. There is a "slot"

between the heatsink and the main chassis which will allow the cable to be routed from bottom to top. However the slot is too narrow to permit the connector to pass through the slot. To widen the slot, temporarily remove or loosen the six heat-sink mounting screws. The screws are located along the left and right edges of the heatsink. After the cable is routed through the slot, replace the heatsink screws and tighten.

- c. Now mount the KPI-380 board to the rear panel connector hole. Remove the hex stud hardware from the KPI-380 and reattach from outside the chassis. Tighten securely. The board mounts so that the ribbon cable goes from the top of the circuit board directly through the heatsink-chassis slot to the top side of the chassis. There are a couple of coax cables which may interfere with the ribbon cable. Just route the cable in any convenient manner.
- d. Now solder the ground wire to the solder lug on the nearby audio out phono jack. This completes the under chassis portion of the installation.
- e. It is now necessary to partially remove the Control Card in order to attach the KPI-380 cable to connector J4 on the Control Card. The procedures are described in Section V of the main text. When the card is high enough, attach the ribbon cable to J4. Note that the KPI-380 connector does not have a blank key position so it could conceivably be installed upside down. We have marked the top of the connector with an etched letter "T". When properly installed the cable exits directly out the side slot in the card cage box. If installed incorrectly the cable would have to fold back over the connector itself before exiting the box. This is incorrect. There is excess length on the KPI-380 cable. The excess should be folded and placed near the right rear corner of the card box, between the box and the filter capacitor.
- f. This completes the installation. Follow the procedures in Section VII of the main text on reinstallation of the Control Card.

- g. Note that the blue cable labeled P11 which goes to the Band Pass Filter card (A4) should go in last. The KPI-380 ribbon cable will be under the band pass filter cable when the Control Card is fully inserted.

3. The Pipo Communications Keypad.

The required key pad is available from Pipo Communications, Box 2020, Pollock Pines, CA 95726, Phone 916-644-5444. The price is \$30.00. Request the "Collins KWM-380 Keyboard." They do not seem to have any other model number designation for this part.

The keypad as you receive it will require the addition of a cable and a back plate or base. We fabricated a back from a piece of blank circuit card material. We used recessed flat head machine screws and felt bumper material to prevent scratching the desktop. Some people have made a metal base which does have the advantage of adding weight. The cable requires 9 wires. We used a 42 inch piece of flat ribbon cable similar to that on the KPI-380 card. It has the advantage of being more flexible than some round cables with nine conductors but this is simply a matter of preference. You will also have to fabricate an exit hole for the cable. In the case of the flat ribbon cable we filed a slot at the top between the actual keypad and the separate piece (included by Pipo) which is called the frame. The keypad pins are located near the bottom but you will want the cable to exit at the top. The pins on the keypad are closely spaced so you will want to insulate each one with heat shrink tubing or spaghetti secured with glue. Note that the frame and the keypad are attached by press-fit pins and can be easily separated. Gluing them together is not necessary and is not recommended.

Electrically the keypad is referred to as having 2 of 8 coding. This means that when a key is pressed both the appropriate row and column pin are connected to +5 volts. Note that in the keypad literature and on the keypad itself pin 9 is referred to as COMMON and that the coding is "two keys connected to COMMON". In our application common is +5 volts, not ground. Pin 10 of the KPI-380 is chassis ground, however no connection from pin 10 to the keypad is required.

The key layout is shown in Figure D1.

The cable pin connections are given in the following table:

Keypad Pin	Function	KPI-380 DB-25 Pin
1	Row 1	1
2	Row 2	2
3	Row 3	3
4	Row 4	4
5	Column 1	5
6	Column 2	6
7	Column 3	7
8	Column 4	8
9	+ 5 volts	9
NC	Ground	10

Table D1: Keypad cable

		Column			
		1	2	3	4
Row	1	1	2	3	STO
	2	4	5	6	RCL
	3	7	8	9	STEP
	4	.	0	ENT	CLR

Figure D1

The Rockwell AC-3803 Control Interface Kit includes a number of outputs from the microprocessor which were intended for the control of an external linear amplifier. Since the promised linear amplifier was never manufactured these signals have been seldom used except by a few experimenters. We deleted them from the KPI-380. This has enabled us to have a cleaner circuit card layout and has helped to keep the cost of our unit lower.

4. Key Pad Operation with Kiron Memory Adapters

a. VFO A/B Frequency Entry.

The operating frequency of the radio can be set from the keypad. As the digits are entered they will appear on the transceiver display but the current operating frequency will not be changed until the ENTER key is pressed. Thus one has visible confirmation of correct entry as it is in progress. The CLR key can be used to start over if a mistake is made.

The MHz portion of the frequency must be separated from the kHz portion by a decimal point. No decimal point is required between the kHz and Hz portions.

The KWM-380 software is written such that trailing zeroes need not be keyed in. This saves many keystrokes. Thus to set the frequency of the active VFO to 14.2 MHz, key in (1 4 point 2 ENT). Frequencies can be entered all the way to the 10 Hz position if desired.

To enter frequencies below 1.0 MHz you must enter a leading zero and the decimal point. Thus for a broadcast station at 680 kHz, press (0 point 6 8 ENT).

Another keystroke saving feature is that you can change to another frequency within the same MHz as currently in use by only entering the decimal point and following digits. For example suppose you want to work a contest by setting to 14.2 and then manually tuning and working stations up to 14.250 and then repeating the process. When you reach 14.250 just press (point 2 enter) to return to the lower end of the range.

To enter into the other VFO the A/B switch must be changed from the front panel and another frequency entered.

b. Memory Storage.

To store the current operating frequency into memory press STO followed by a two digit number between 00 and 99. Memories

(also referred to as presets) below ten require a leading zero (e.g. 07).

Frequencies can be stored in memory without changing the current operating frequency. This is convenient in that you can continue listening to a net while loading memories. Just key in the frequency followed by STO and the two digit preset number. The display will automatically return to the operating frequency at the end of the STO operation.

c. Frequency Recall.

To load a frequency from memory into the active VFO just press RCL followed by the two digit preset number.

In the original Rockwell software if one entered RCL and a memory location that had a zero frequency installed the command would be carried out and the VFO would be set to 0.000.00. Try this. Manually set the VFO to .000.00 with the tuning knob. This is equivalent to sending a zero frequency command from the control card to the synthesizer. The S-meter reads the strength of an internal oscillator. When we implemented 100 memories, many of which might not be in use, the Rockwell scheme quickly became an annoyance. Our Kiron Memory Adapters are programmed to simply ignore a RCL from a storage location if that location contains a zero frequency.

d. Frequency Stepping.

The memories can be stepped through in sequence by repeated presses of the step (STP) key. Only those memories which have non-zero frequencies stored will be included in the sequence. For example if you have only stored in memory locations 06, 13, and 82, the STP key will cause only the three frequencies stored in these locations to be accessed.

e. Clearing Memory Locations.

To quickly clear all 100 memories turn off the transceiver power. Then press the 5 and the CLR keys with two fingers and

while holding the two keys down, turn on the transceiver power. Wait until the beeping stops (three or four beeps). Then release the keys. At this point all memories are cleared to zero and VFOs A and B are set to 15.0 MHz. An individual memory location can be cleared by entering 0.0 STO followed by the two digit preset number. This can be done while listening to another frequency. If you want to clear several locations set the VFO manually to .000.00 with the tuning knob. Then press STO followed by the number for each location to be cleared. Then tune away from zero frequency to restore operation of the transceiver.

Appendix E

Connection of the KWM-380 to a Computer

Kiron Corporation now offers a set of short computer programs which allow control of the KWM-380 from a personal computer. Since new products are introduced from time to time we will not describe the current offerings in this manual. Write us for the latest product description sheets. The purpose of this appendix is to describe in general terms the type of control which can be implemented from a computer. The information should also be useful if you are a programmer and wish to write your own program.

Numerous transceivers now on the market were designed for control from a computer. For example the Kenwood TS-940 has 25 functions which can be set or read from a computer. This includes changing the frequency of one of the VFOs or reading the current VFO frequency.

Although the KWM-380 was designed several years earlier it is possible to implement a limited control by connecting the computer in place of the keypad. If the computer has a parallel port such as a printer port it is only necessary to make a special cable. No other hardware is required. If the computer only has a serial port then a simple hardware serial to parallel converter would be needed between the computer and the keypad connector of the KWM-380.

Remember that the keypad is an input device only. Therefore we will be limited to sending commands from the computer to the KWM-380. There can be no transfer of information in the other direction. The computer program will simply reproduce in sequence and more quickly what you can do manually from the keypad. Thus we can store frequencies in memory or recall from memory to the active VFO (that is the one currently selected by the manual front panel A/B switch). In addition the STP command can be used to cycle through memories. It is also possible to implement a form of scanning where you would set a new frequency and dwell on it for a certain time, perhaps 5 seconds, and then move to the next frequency. Since the radio has no squelch and there is no communication from the radio to the computer one cannot stop on a busy channel as is commonly done in VHF radios.

The simplest program might ask you to enter a frequency. Then it would request you to state a destination (that is memory 26 for example). Then a carriage return would carry out the operation. Verification would consist of issuing a RCL 26 from the computer and observing the LED display. Another program could be written which would read from a disc file and load all 100 memories. A word processor could be used to create and edit the memory data file. If the software were properly designed you could have a comment field in the data file you create with the word processor which would be ignored by the upload program.

As far as hardware is concerned as mentioned above it is easiest if the computer has a parallel port such as a printer port. The available computer language must allow sending an 8 bit character to the port. For an IBM PC or clone with a parallel printer port we can specify the required interconnect cable. The IBM uses a DB-25 connector for the printer port. So we need a 9 wire cable with DB-25 connectors on both ends and with connections as shown in Table E1. Note the difference between this cable and the one for the keypad as described in Appendix D. Pin 9 of the keypad which normally goes to +5 volts obtained from pin 9 of the KWM-380 DB-25 connector is not used in this application. In this cable pin 10 of the keypad is used whereas it is not required on the normal keypad cable. Unfortunately this cable needs to have a male DB-25 on both ends so it will be necessary to clearly label the cable ends when it is completed.

When the program wishes to simulate the pressing of a keypad key, it must set two of the bits high, that is to a 1. So for each key we have a code or number to be sent from the computer to the printer port. The codes are given in Table E2.

IBM Computer Pin	Keypad Function	Keypad Pin	Function
2	D0	1	Row 1
3	D1	2	Row 2
4	D2	3	Row 3
5	D3	4	Row 4
6	D4	5	Column 1
7	D5	6	Column 2
8	D6	7	Column 3
9	D7	8	Column 4
18 - 25	Grnd	10	Grnd

Table E1: KWM-380 to Computer Cable

Key	D7 - D0	Hex	Decimal	Character
1	0001 0001	11	17	Ctrl-Q
2	0010 0001	21	33	!
3	0100 0001	41	65	A
4	0001 0010	12	18	Ctrl-R
5	0010 0010	22	34	" (quote)
6	0100 0010	42	66	B
7	0001 0100	14	20	Ctrl-T
8	0010 0100	24	36	\$
9	0100 0100	44	68	D
0	0010 1000	28	40	(
point	0001 1000	18	24	Ctrl-X
ENT	0100 1000	48	72	H
STO	1000 0001	81	129	Note
RCL	1000 0010	82	130	Note
STP	1000 0100	84	132	Note
CLR	1000 1000	88	136	Note

Table E2: Keypad Codes

Note: Different computers handle the so-called graphics characters differently. These are the last four characters in the above table and are the ones with the high bit set. Refer to your computer manual.

The final piece of information that we need to know is that the KWM-380 requires that the key be pressed for approximately 10 milliseconds. Also the key must be released for 10 milliseconds before the next key is pressed. Your software must simulate the same sequence of key presses that you would press manually and be correctly timed. The steps are as follows:

1. Write the value of the key to the port.
2. Wait for at least 10 milliseconds.
3. Write zero to the port.
4. Wait for at least 10 milliseconds.
5. Repeat steps 1 - 4 for each key.

How can you obtain a 10 millisecond delay? It is usually easy to write a loop that does not do anything, just to waste time. In assembly language the time can be easily calculated; however, in BASIC it may be difficult to know exactly how long a loop will take to complete. Fortunately trial and error is usually satisfactory. If the KWM-380 fails to receive the proper frequency increase the loop counter. If it takes too long to send a frequency, try reducing the loop count until errors occur.

A conventional computer A/B port switch can be used to conveniently switch from normal printer operation to computer control of the radio.

PRODUCT WARRANTY

To the original owner, KIRON CORPORATION warrants the KIRON Memory Adapter to be free of defects in materials or workmanship for a period of six months from the date of purchase.

The warranty registration card must be submitted within 10 days of the date of purchase in order to obtain warranty service. All units returned for repair must have prior authorization from KIRON. A return authorization number may be obtained by phone or letter. All returns must be shipped prepaid. Repaired units will be returned with shipping paid by us using normal surface shipping carriers (UPS or US Postal Service).

This warranty does not apply to units which have been misused, or become defective through user modification, negligence, abuse and/or mishandling, or improper installation. KIRON assumes no responsibility for any damage to the radio to which this product is connected.

During the warranty period KIRON agrees to repair or replace, at our option, the Memory Adapter Board, without charge and within a reasonable time, any unit returned to us which upon examination is found to be defective under the terms of this warranty.

KIRON reserves the right to change any feature or specification of the product at any time without incurring obligation to previous purchasers.

In no event shall KIRON have any liability for incidental or consequential damages, or for loss, damage or expense directly or indirectly arising from the use of this product. (Some states do not allow limitations on how long an implied warranty lasts or the exclusion or limitation of incidental or consequential damages, so the above limitations or exclusions may not apply to you.)

This warranty gives you specific legal rights, and you may also have other rights which vary from state to state.

KIRON CORPORATION Columbus, OH 43221

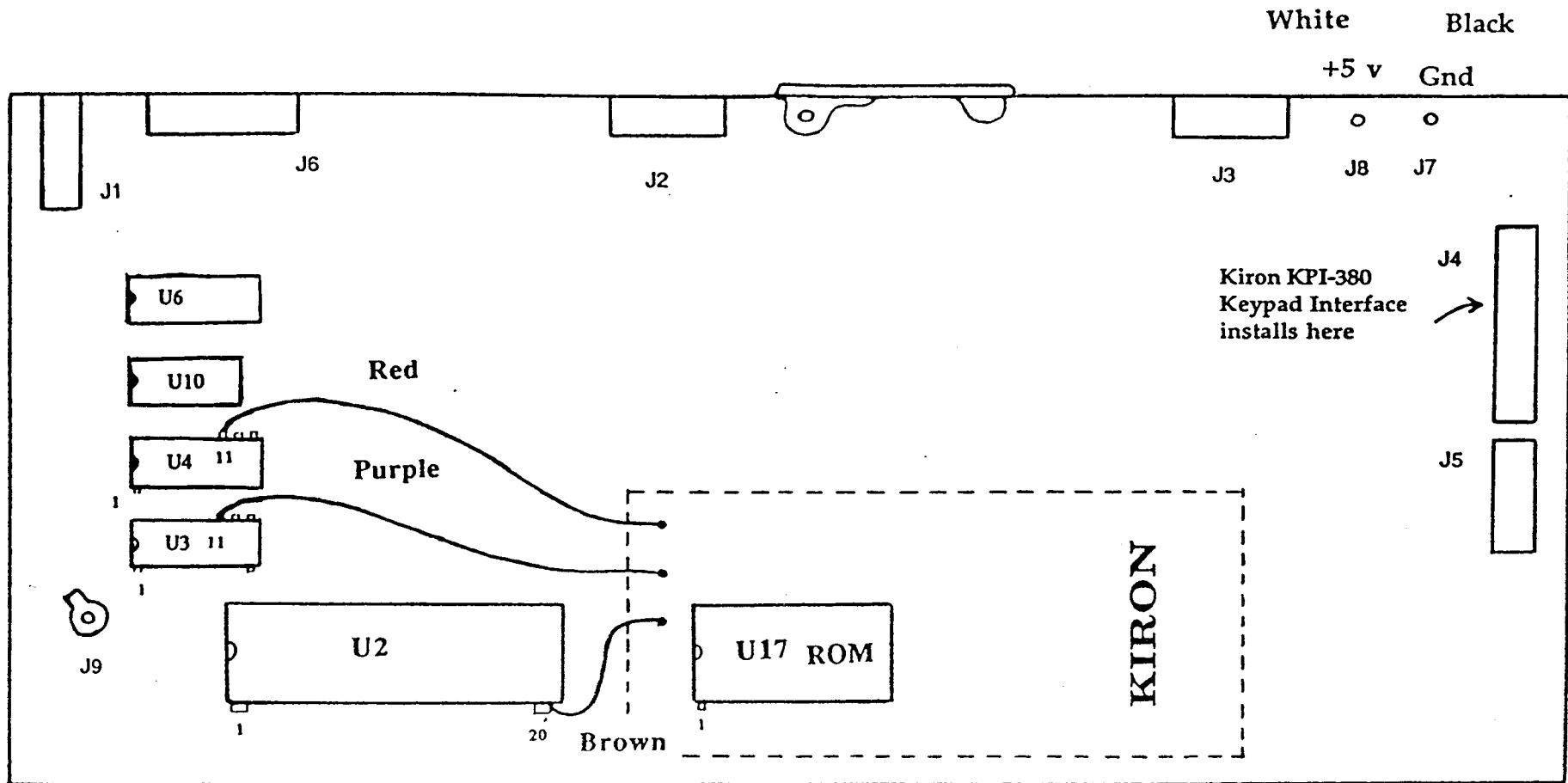

Control Card (A8) Showing Installation of Kiron Memory Adapter